

A

A

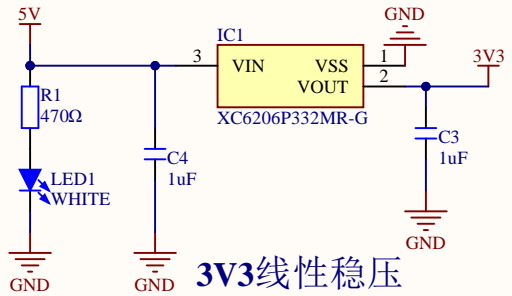

3V3线性稳压

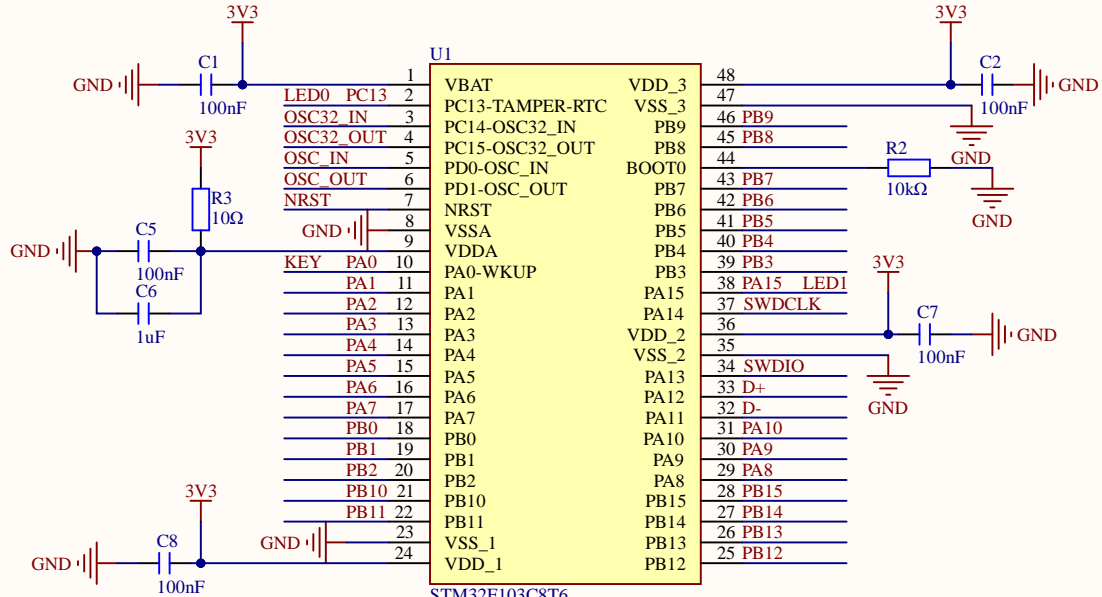

主控芯片

B

B

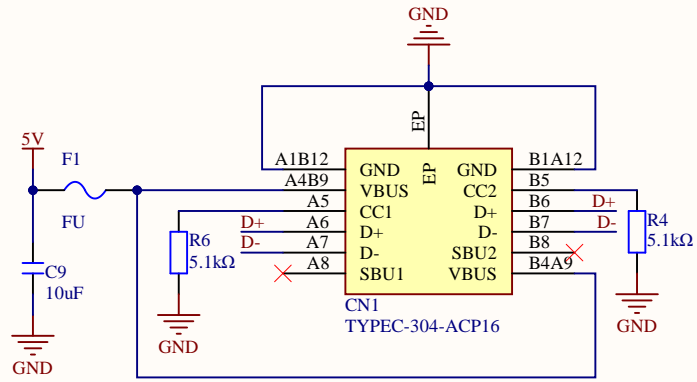

TYPEC接口

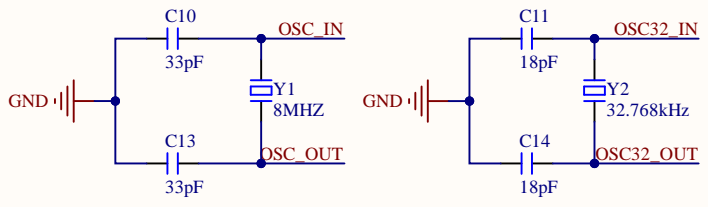

晶振电路

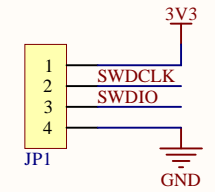

SW调试

C

C

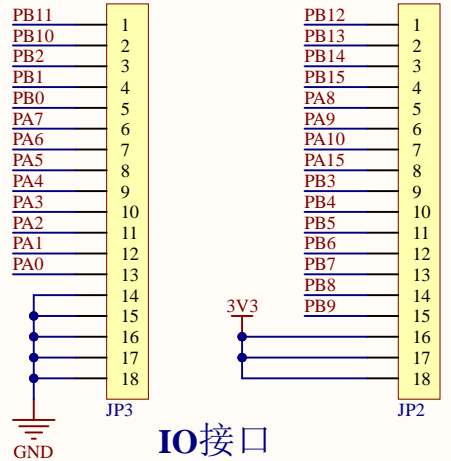

IO接口

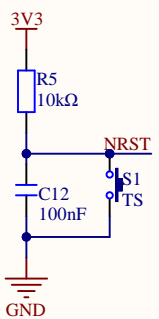

复位电路

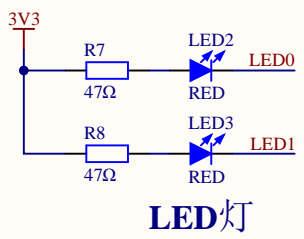

LED灯

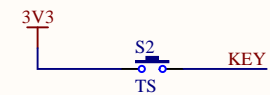

按键

D

D

Title		
Size	Number	Revision
A		
Date:	4/12/2026	Sheet of
File:	D:\1-STM32工程\...\Sheet1.SchDoc	Drawn By:

